

NOTES:

1. MATERIAL: AISI 304 STAINLESS STEEL.

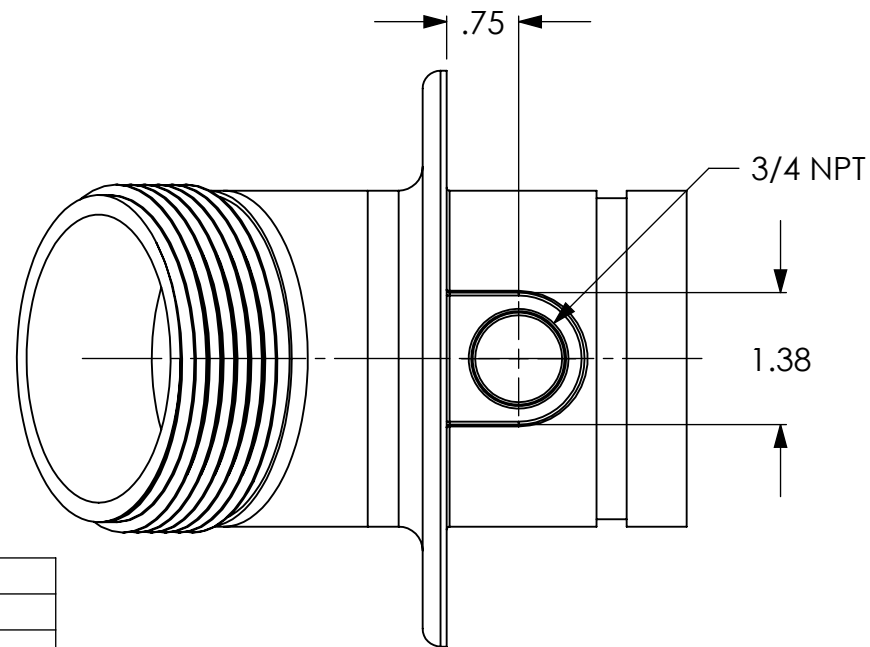
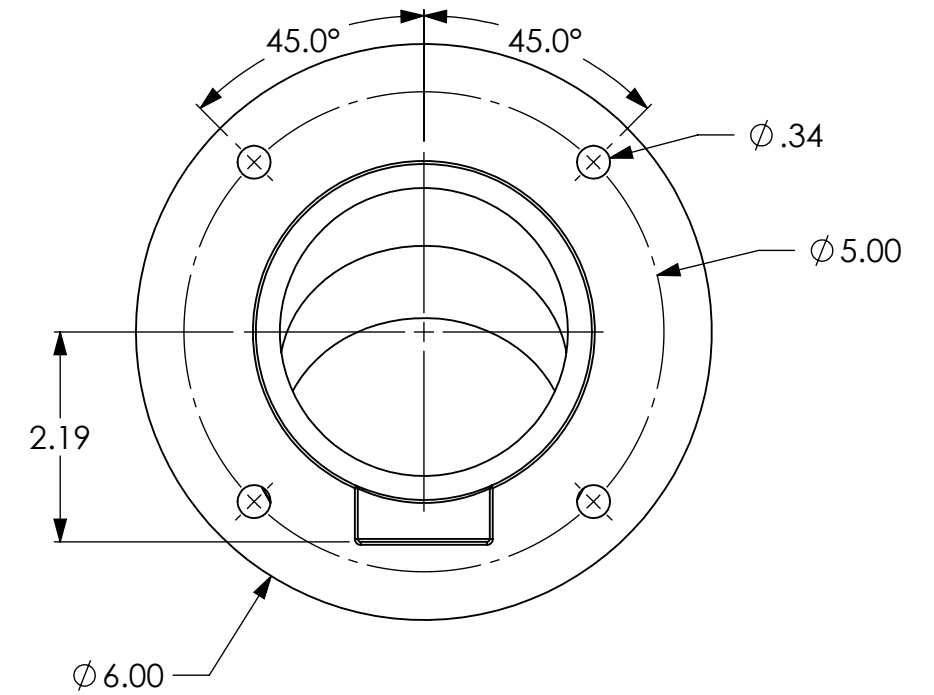
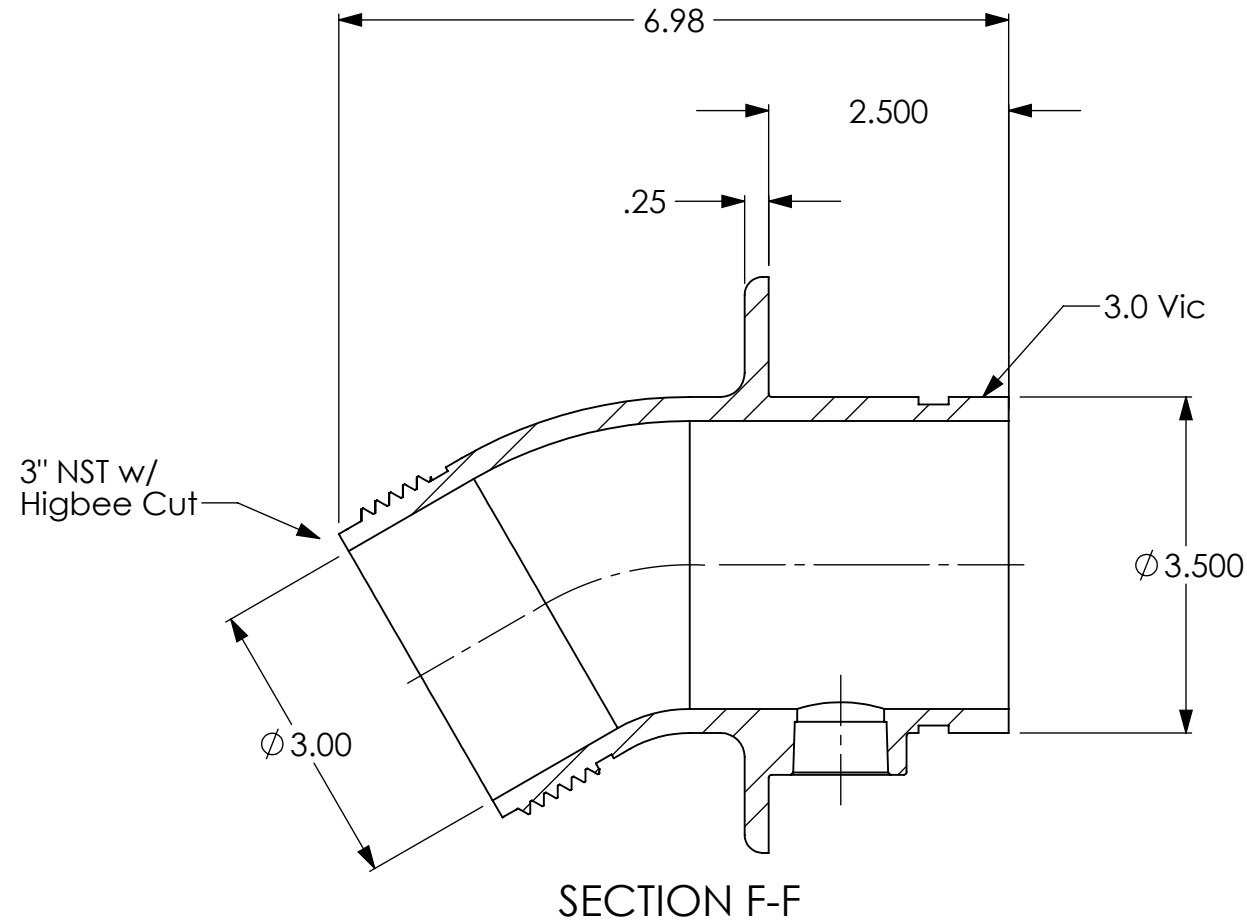
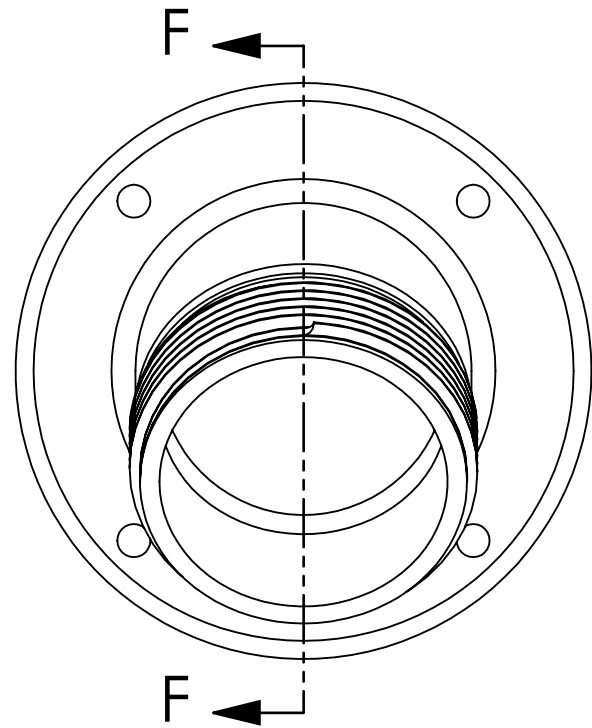
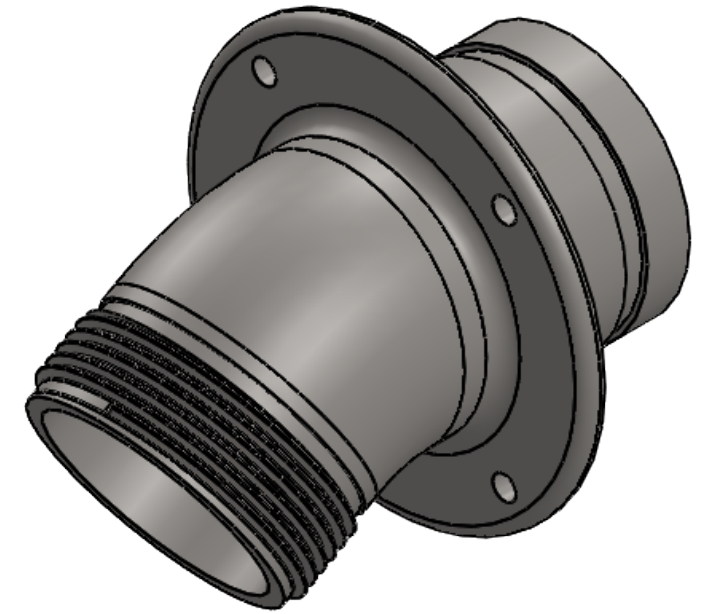

<p>DRAWING NOTES UNLESS OTHERWISE SPECIFIED</p> <ol style="list-style-type: none"> All dimensions are in inches. Do not scale drawing. Decimal Tolerance X.XX = +/- 0.01 Decimal Tolerance X.XXX = +/- 0.005 Fractional Tolerance X/X = +/- 1/16 Angle Tolerance: 0.5 degrees 	<p>FirePrograms</p> <p>6405 SW 38th St, Bldg 200 Ocala, FL 34474 Phone: 800.327.7638 www.fireprograms.com</p>	
	<p>TITLE</p> <p>Cstg 3.0 NST 30 Deg x 3.0 V w/ Mtg Flange</p>	
<p>APPROXIMATE WEIGHT (LBS)</p> <p>6.038</p>	<p>DRAWING NUMBER</p> <p>500242</p>	<p>REV</p> <p>A</p> <p>DATE</p> <p>5/6/2020</p>
<p>THE INFORMATION CONTAINED IN THIS DRAWING IS THE SOLE PROPERTY OF FIRE PROGRAMS, LLC. ANY REPRODUCTION IN PART OR AS A WHOLE WITHOUT THE WRITTEN PERMISSION OF FIRE PROGRAMS, LLC IS PROHIBITED.</p>	<p>SHEET SCALE</p> <p>1:2</p> <p>SHEET</p> <p>1 OF 1</p>	

REVISIONS		
REV.	DATE	DESCRIPTION
A	5/6/2020	Initial Release